

ECE 6345

Spring 2015

Prof. David R. Jackson
ECE Dept.

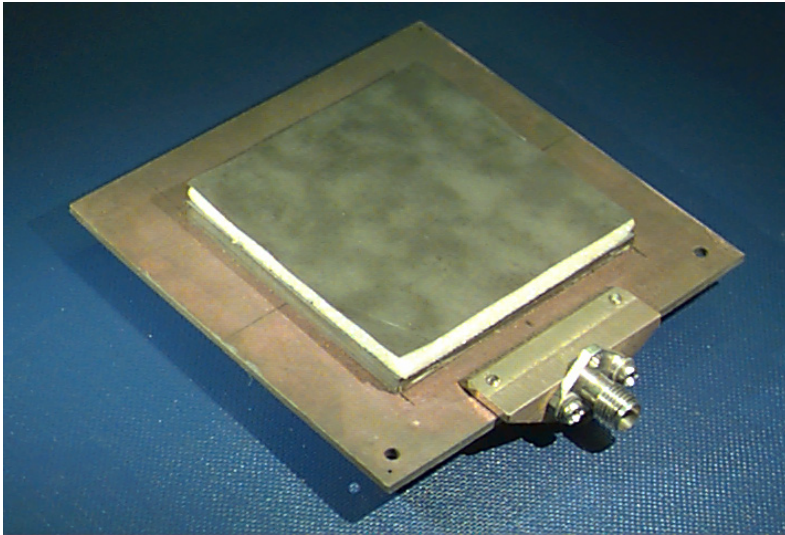

Notes 19

Overview

In this set of notes we introduce the Spectral Domain Immitance (SDI) method, which is a powerful method for solving for the fields due to sources inside of layered media.

- The basic idea is developed here by decomposing a finite current sheet (e.g. a patch antenna) into a set of infinite phased current sheets.
- The fields are found from an infinite phased current sheet.
- The fields from the infinite current sheets are added together (spectral integration) to recover the fields of the finite current sheet.

Spectral Domain Immitance Method

- We initially consider a planar source inside of a layered structure. (The method can be extended to include vertical sources as well.)
- The figure shows a single layer, but the method works for any number of layers.

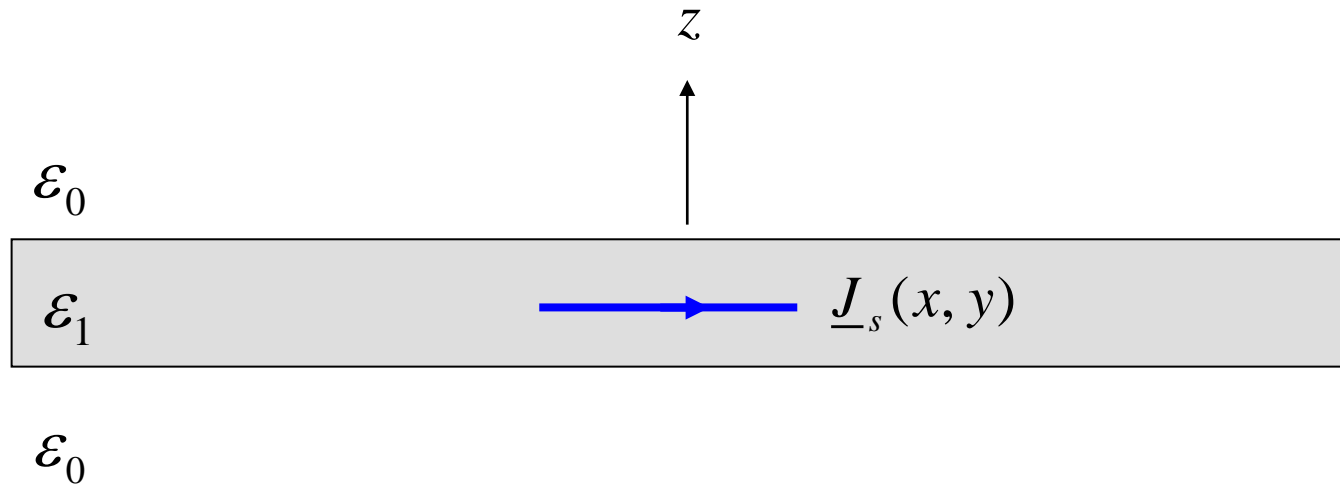

SDI Method (cont.)

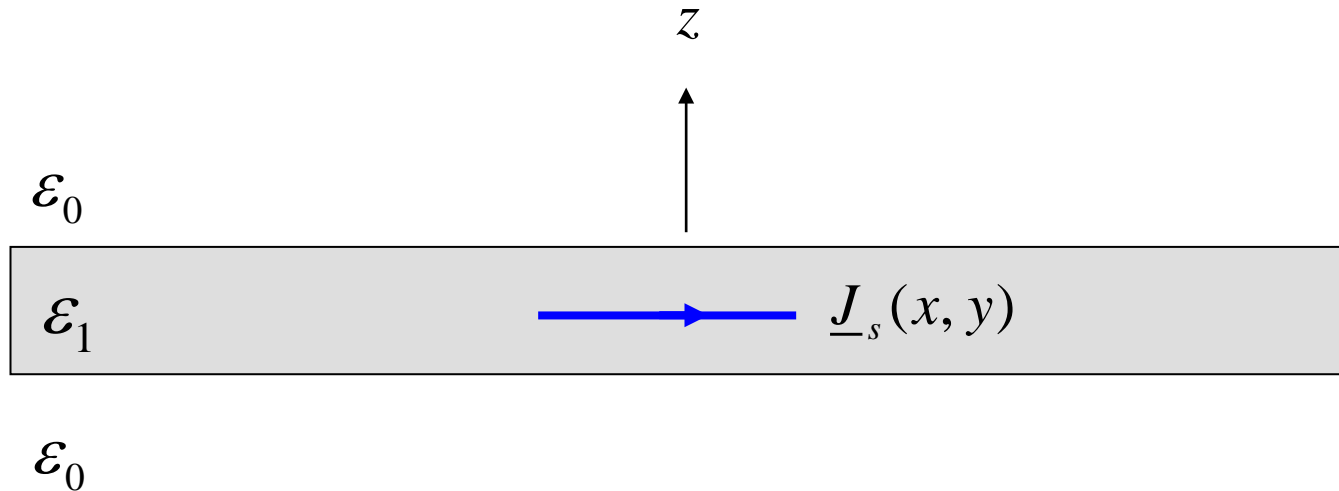

Introduce Fourier transform pair:

$$\underline{\tilde{J}}_s(k_x, k_y) = \int_{-\infty}^{+\infty} \int_{-\infty}^{+\infty} \underline{J}_s(x, y) e^{j(k_x x + k_y y)} dx dy$$

$$\underline{J}_s(x, y) = \frac{1}{(2\pi)^2} \int_{-\infty}^{+\infty} \int_{-\infty}^{+\infty} \underline{\tilde{J}}_s(k_x, k_y) e^{-j(k_x x + k_y y)} dk_x dk_y$$

$$x, y \in (-\infty, \infty)$$

Considering the integrals as limits of sums, we can write:

$$\underline{J}_s(x, y) \approx \sum_{m=-\infty}^{\infty} \sum_{n=-\infty}^{\infty} \frac{1}{(2\pi)^2} \underline{\tilde{J}}_s(k_{xm}, k_{yn}) \Delta k_x \Delta k_y e^{-j(k_{xm} x + k_{yn} y)}$$

SDI Method (cont.)

$$\underline{J}_s(x, y) \approx \sum_{m=-\infty}^{\infty} \sum_{n=-\infty}^{\infty} \frac{1}{(2\pi)^2} \tilde{\underline{J}}_s(k_{xm}, k_{yn}) \Delta k_x \Delta k_y e^{-j(k_{xm}x + k_{yn}y)}$$

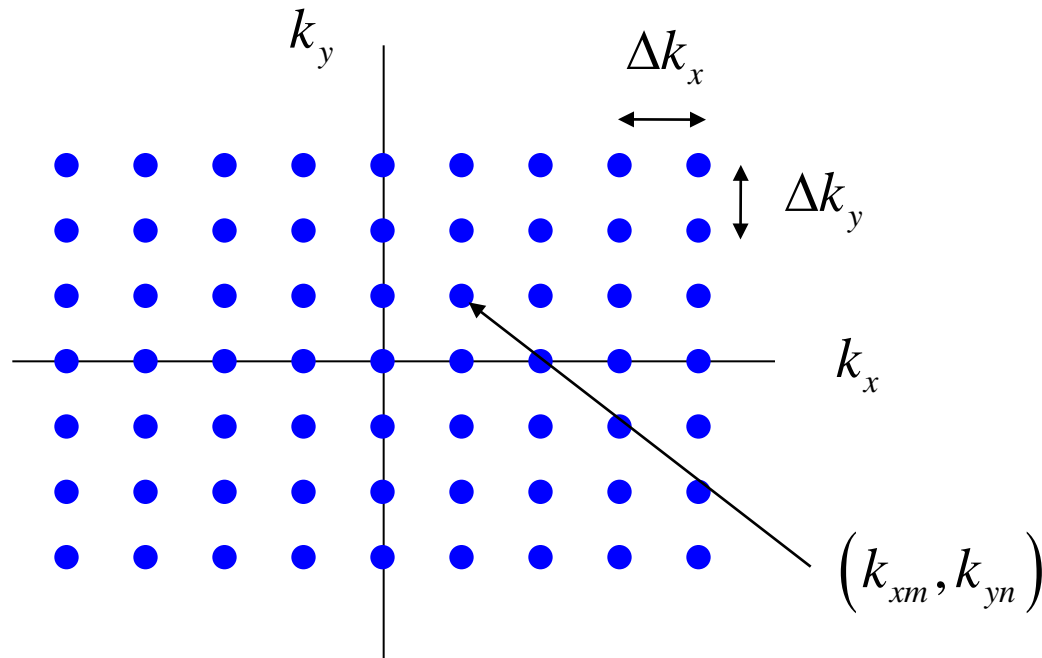

SDI Method (cont.)

$$\underline{J}_s(x, y) = \sum_{m=-\infty}^{\infty} \sum_{n=-\infty}^{\infty} \frac{1}{(2\pi)^2} \tilde{\underline{J}}_s(k_{xm}, k_{yn}) \Delta k_x \Delta k_y e^{-j(k_{xm}x + k_{yn}y)}$$

Denote:
$$\underline{A}_{mn} = \frac{1}{(2\pi)^2} \tilde{\underline{J}}_s(k_{xm}, k_{yn}) \Delta k_x \Delta k_y$$

Then
$$\underline{J}_s(x, y) = \sum_{m=-\infty}^{\infty} \sum_{n=-\infty}^{\infty} \underline{A}_{mn} e^{-j(k_{xm}x + k_{yn}y)}$$

The finite-size current sheet is thus expressed as a superposition of infinite phased current sheets.

SDI Method (cont.)

We can write this as

$$\underline{J}_s(x, y) = \sum_{m=-\infty}^{\infty} \sum_{n=-\infty}^{\infty} \underline{J}_s^{mn}(x, y)$$

where

$$\underline{J}_s^{mn}(x, y) = \underline{A}_{mn} e^{-j(k_{xm}x + k_{yn}y)}$$

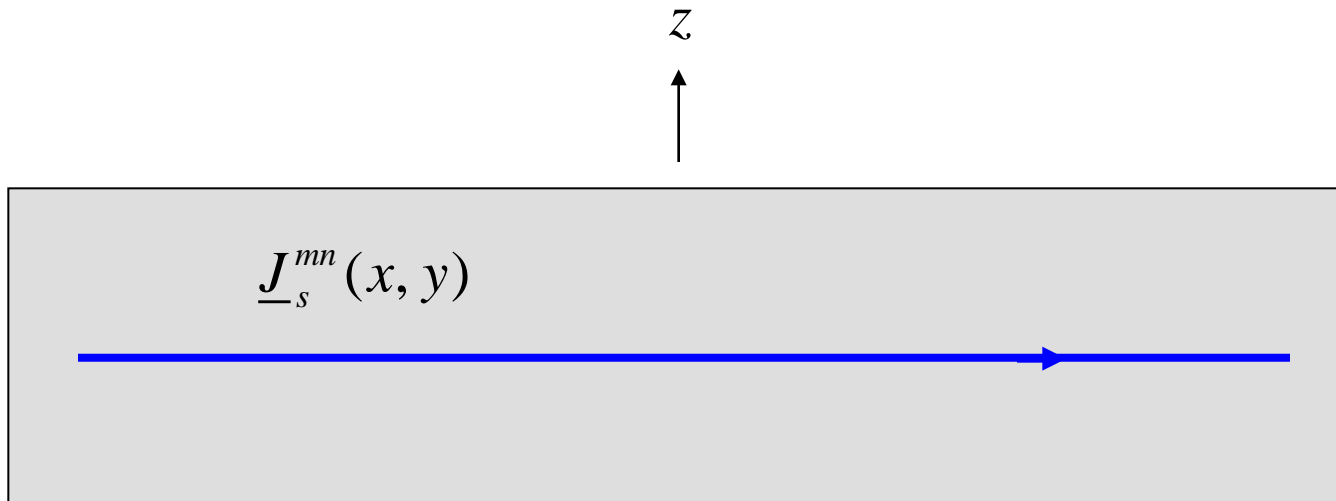

SDI Method (cont.)

Consider a single sheet of current of the form:

$$\underline{J}_s^p(x, y) = \underline{J}_{s0}^p e^{-j(k_x x + k_y y)}$$

The superscript p stands for “phased current sheet.”

The zero subscript means “at the origin.”

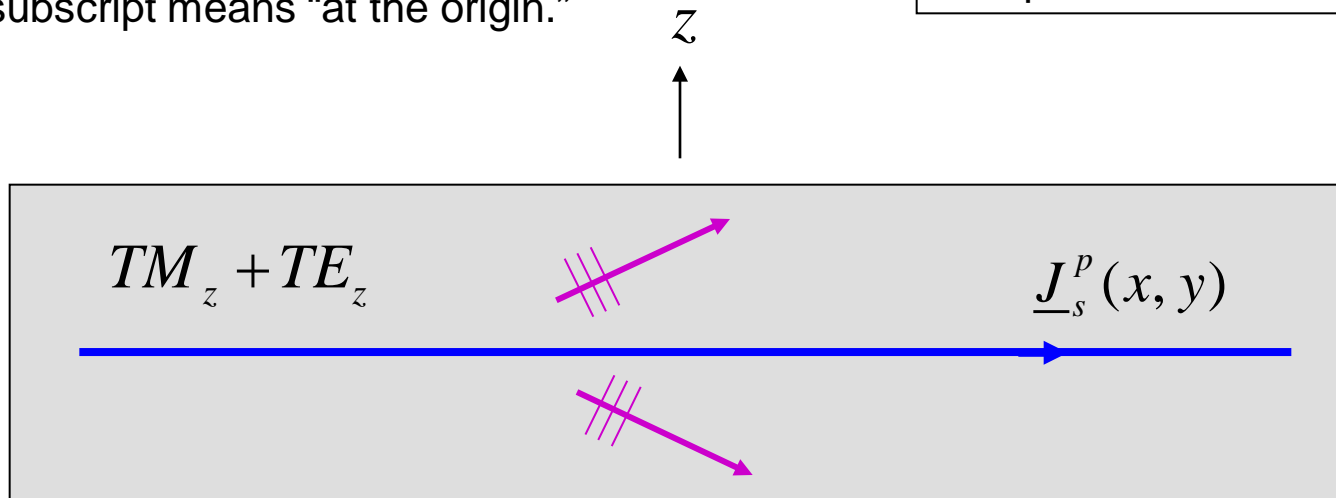

We wish to determine the amplitude of the plane waves that this current source launches, and the field at any point inside the structure.

Note: TM_z and TE_z waves reflect from the boundary and remain TM_z and TE_z , respectively.

SDI Method (cont.)

The current sheet launches a pair of plane waves that propagate up and down.

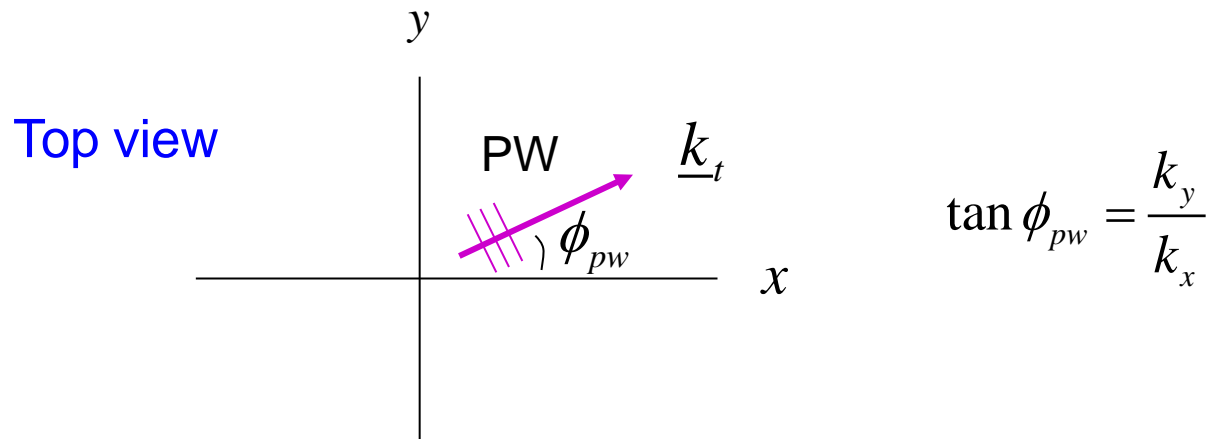
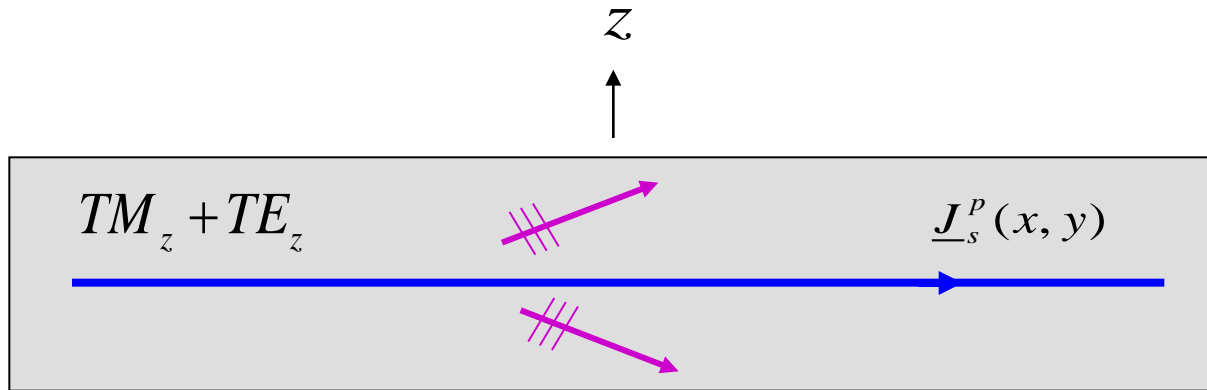

TM_z PW

3D view

The upward-going TM_z plane wave inside the layer is shown here.

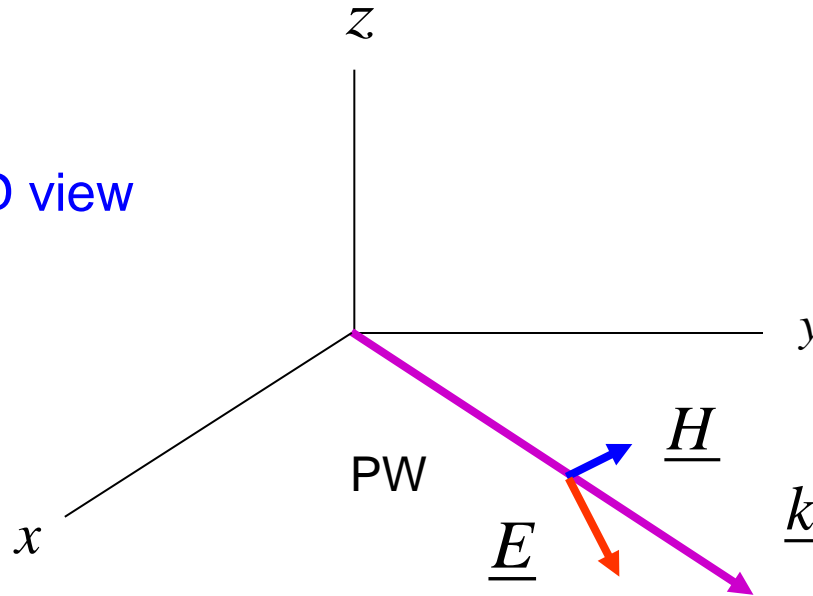

Top view

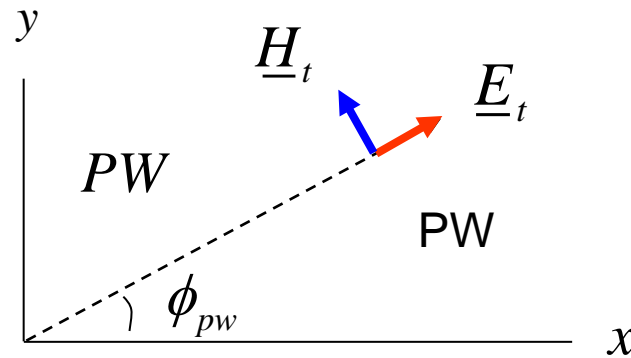

TM_z PW (cont.)

Denote

$$\underline{\hat{u}} = \underline{\hat{k}}_t = \underline{\hat{x}} \cos \phi_{pw} + \underline{\hat{y}} \sin \phi_{pw} = \underline{\hat{x}} \left(\frac{k_x}{k_t} \right) + \underline{\hat{y}} \left(\frac{k_y}{k_t} \right)$$

and

$$\underline{\hat{v}} = \underline{\hat{z}} \times \underline{\hat{u}}$$

Note: These unit vectors depend on the values of (k_x, k_y) .

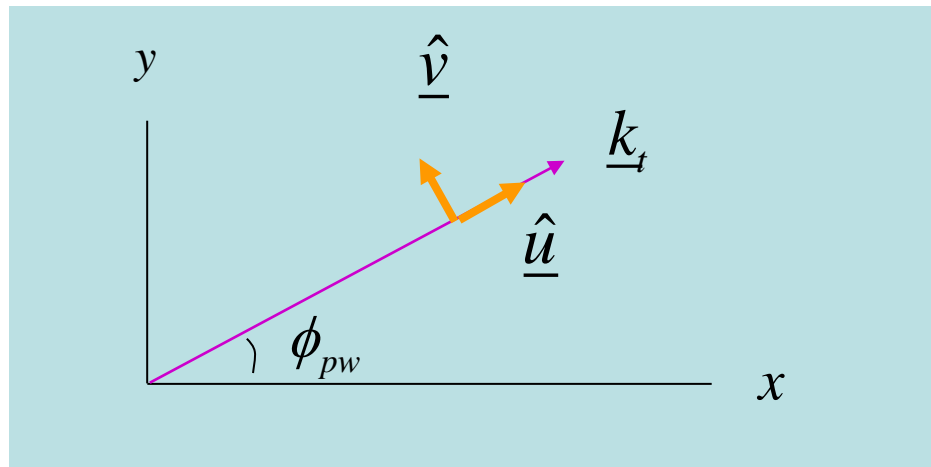

TM_z PW (cont.)

For the TM_z plane wave, we then have

$$\underline{E}_t = \hat{u} E_u$$

$$\underline{H}_t = \hat{v} H_v$$

The “*t*” subscript means “transverse (perpendicular) to the *z* direction.”

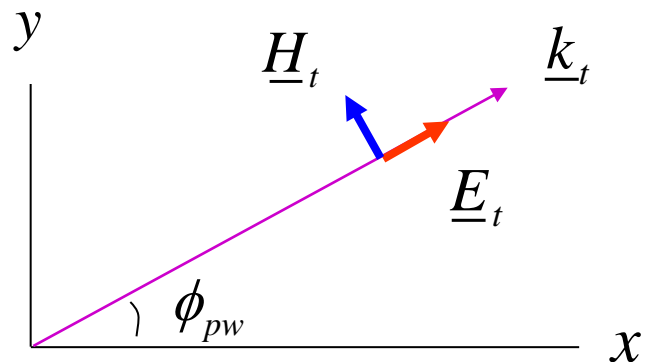

TE_z PW

The upward-going TE_z plane wave is polarized as shown here.

$$\underline{H}_t = \hat{u} H_u$$

$$\underline{E}_t = \hat{v} E_v$$

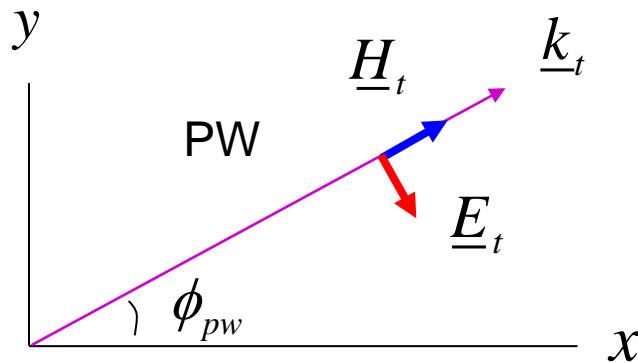
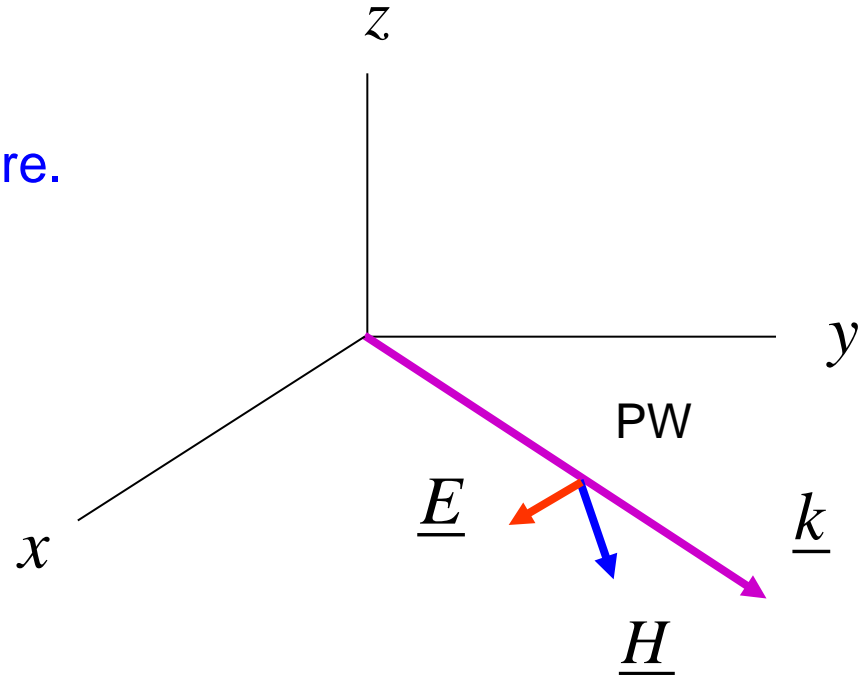

Wave Impedances

The wave impedances are calculated for waves traveling upward.

TM_z :

$$\frac{E_u}{H_v} = Z^{TM} = \frac{k_z}{\omega \epsilon}$$

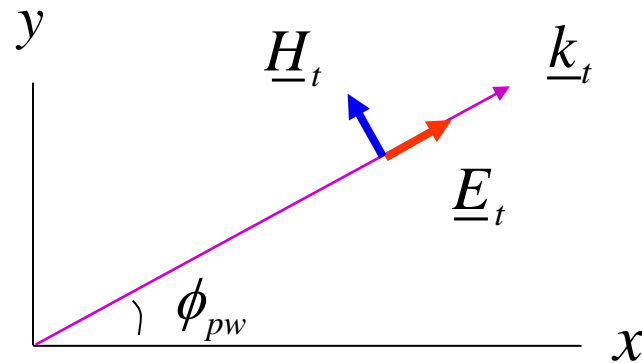

TE_z :

$$\frac{-E_v}{H_u} = Z^{TE} = \frac{\omega \mu}{k_z}$$

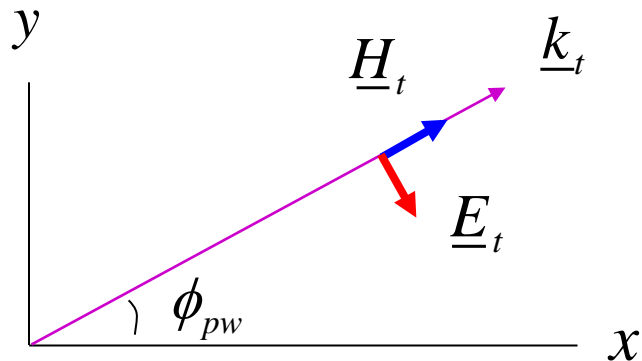

TEN: TM_z PW

Consider the plane waves that gets launched by the current sheet:

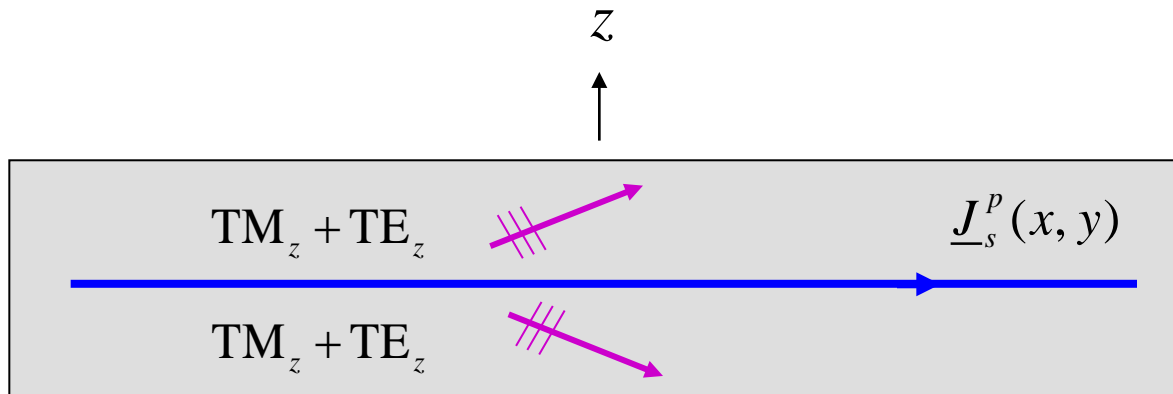

We wish to use a TEN model to find the plane-wave field inside the layered structure.

TEN: TM_z PW (cont.)

We introduce the following modeling equations:

$$V^{TM}(z) = E_u(0,0,z) = E_{u0}(z)$$

$$I^{TM}(z) = H_v(0,0,z) = H_{v0}(z)$$

The zero subscript indicates that the field has the exponential phase term suppressed.

Note that the voltage (tangential electric field) must be continuous at the source location, so the source model is a parallel element.

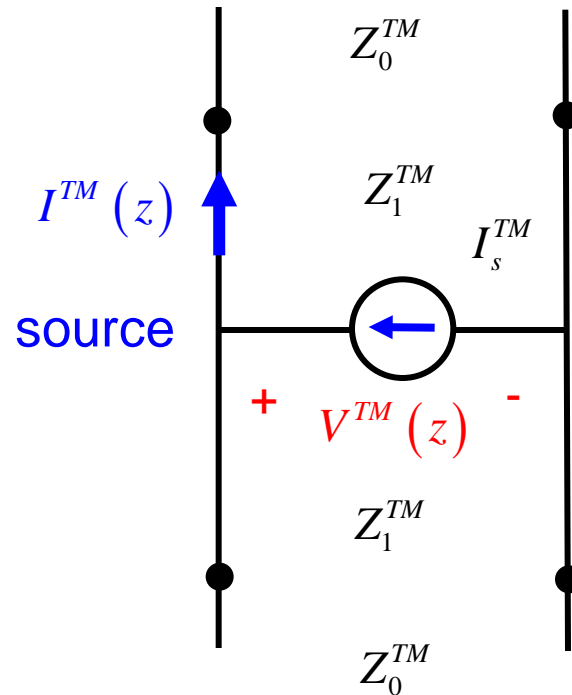
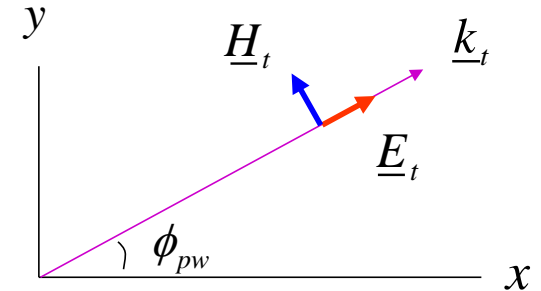

TEN model

$$k_{zi} = (k_i^2 - k_x^2 - k_y^2)^{1/2}$$

$$= (k_i^2 - k_t^2)^{1/2}$$

TEN: TE_z PW

We introduce similar modeling equations for the TE_z case:

$$V^{TE}(z) = -E_v(0,0,z) = -E_{v0}(z)$$

$$I^{TE}(z) = H_u(0,0,z) = H_{u0}(z)$$

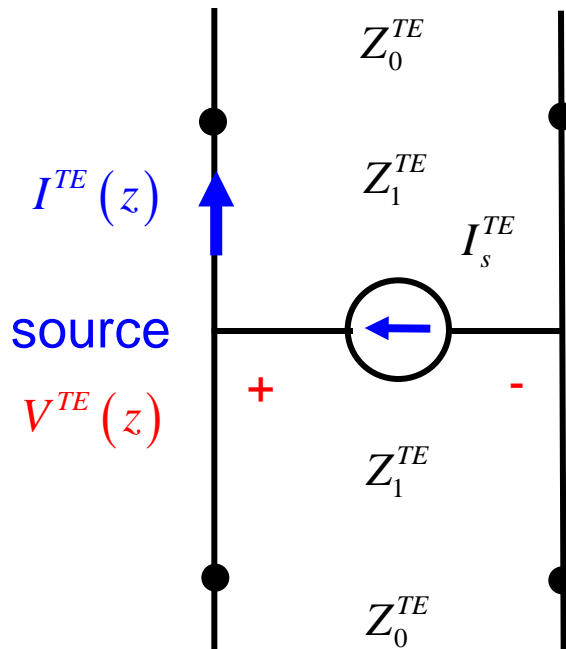
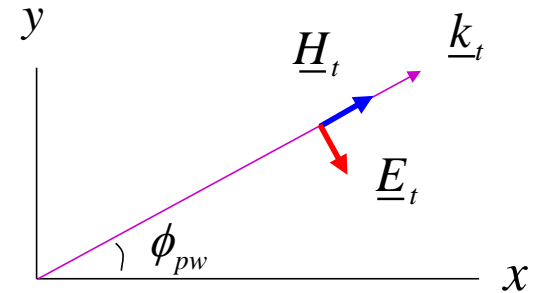

TEN model

$$k_{zi} = (k_i^2 - k_x^2 - k_y^2)^{1/2}$$

$$= (k_i^2 - k_t^2)^{1/2}$$

Source Model (cont.)

Denote

$$\underline{J}_s^P(x, y) = \underline{J}_s^{P^{TM}}(x, y) + \underline{J}_s^{P^{TE}}(x, y)$$

$$\begin{aligned}\underline{J}_s^{P^{TM}}(x, y) &= \hat{z} \times \left(\underline{H}_t^{+TM}(x, y, 0) - \underline{H}_t^{-TM}(x, y, 0) \right) \\ &= \hat{z} \times \left(\hat{v} H_v^+(x, y, 0) - \hat{v} H_v^-(x, y, 0) \right) \\ &= -\hat{u} \left(H_v^+(x, y, 0) - H_v^-(x, y, 0) \right) \\ &= -\hat{u} e^{-j(k_x x + k_y y)} \left(H_v^+(0, 0, 0) - H_v^-(0, 0, 0) \right) \\ &= -\hat{u} e^{-j(k_x x + k_y y)} \left(I^{TM}(0^+) - I^{TM}(0^-) \right) \\ &= -\hat{u} e^{-j(k_x x + k_y y)} I_s^{TM}\end{aligned}$$

The TM current is that part of the total current that launches only a TM_z plane wave, while the TE current launches only a TE_z plane wave.

The source is assumed to be at $z = 0$.

Conclusion: The current that launches the TM_z plane wave is polarized in the u direction.

Source Model (cont.)

Hence $\underline{J}_s^{P^{TM}}(x, y) = \hat{u} \left(\hat{u} \cdot \underline{J}_s^P(x, y) \right)$

Similarly, $\underline{J}_s^{P^{TE}}(x, y) = \hat{v} \left(\hat{v} \cdot \underline{J}_s^P(x, y) \right)$

$$\underline{J}_s^P(x, y) = \hat{u} \left(\underline{J}_s^{P^{TM}}(x, y) \right) + \hat{v} \left(\underline{J}_s^{P^{TE}}(x, y) \right)$$

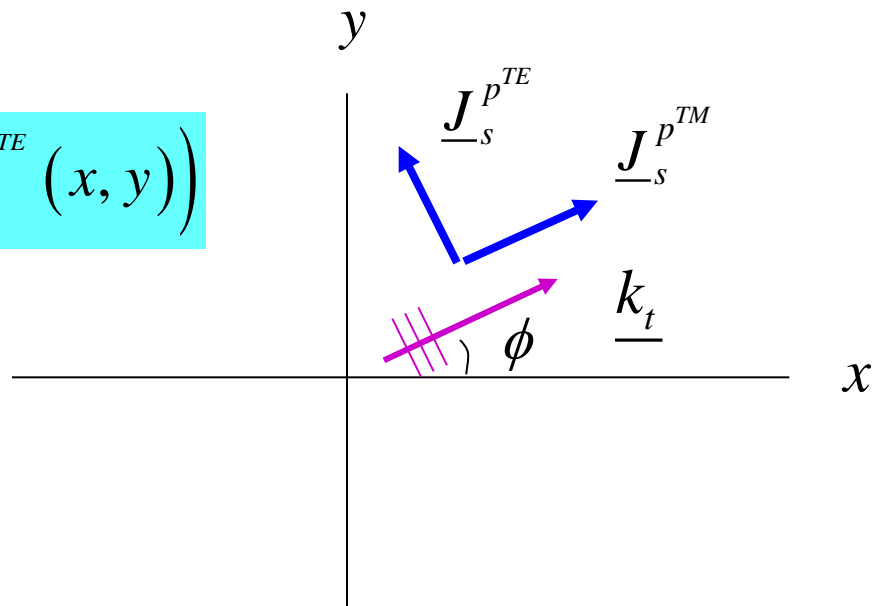

Source Model (cont.)

We can now determine the **source amplitude** in the TEN model:

Recall: $\underline{J}_s^{pTM}(x, y) = -\underline{\hat{u}} e^{-j(k_x x + k_y y)} I_s^{TM}$

$$\underline{\hat{u}} \cdot \underline{J}_s^{pTM} = \underline{\hat{u}} \cdot \underline{J}_s^p = \underline{\hat{u}} \cdot \left(-\underline{\hat{u}} e^{-j(k_x x + k_y y)} I_s^{TM} \right)$$

so $I_s^{TM} = -\underline{\hat{u}} \cdot \underline{J}_s^p(x, y) e^{j(k_x x + k_y y)}$

or $I_s^{TM} = -\underline{\hat{u}} \cdot \underline{J}_{s0}^p$

Similarly,

$$I_s^{TE} = \underline{\hat{v}} \cdot \underline{J}_{s0}^p$$

The zero subscript indicates that the current has the exponential phase term suppressed.

TEN

The TEN models are shown below.

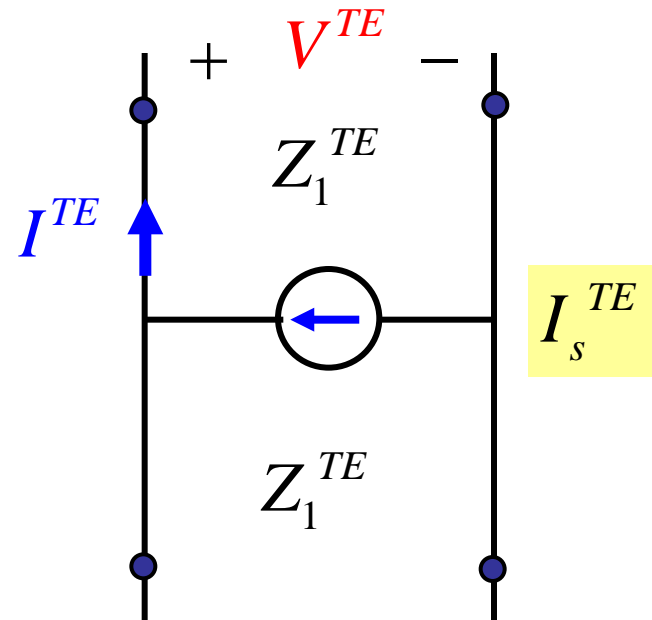
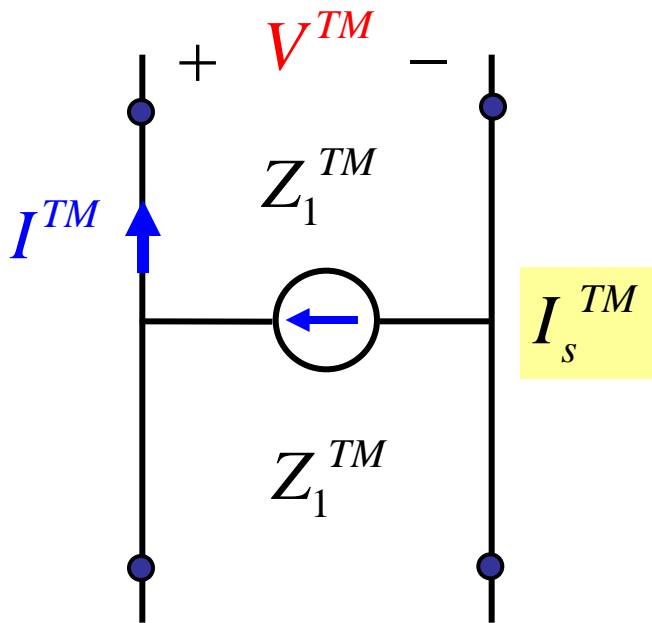

Example

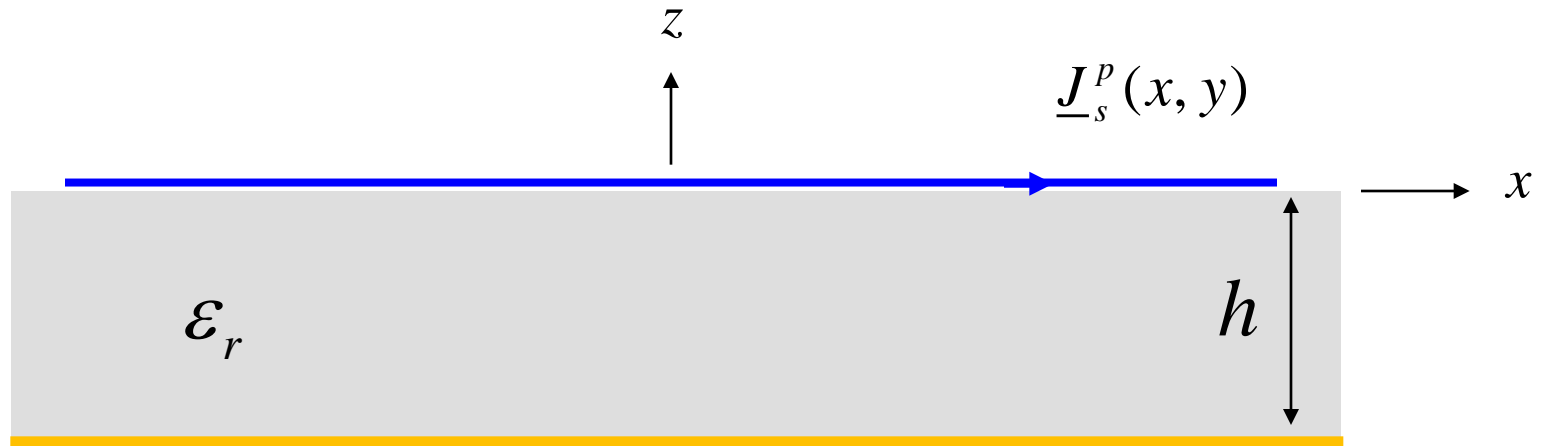

Assume $\underline{J}_s^p(x, y) = \hat{x} e^{-jk_0(x+y)}$

Find $\underline{E}_t(x, y)$ for $z \geq 0$

Note: If we wanted to find E_z , we would need to find the transverse magnetic field first, and then apply Ampere's law.

Example (cont.)

$$\underline{J}_s^p(x, y) = \underline{\hat{x}} e^{-jk_0(x+y)}$$

In this example we have

$$k_x = k_0$$

$$k_y = k_0$$

The unit vectors are

$$\underline{\hat{u}} = \frac{1}{\sqrt{2}}(\underline{\hat{x}} + \underline{\hat{y}})$$

$$\underline{\hat{v}} = \underline{\hat{z}} \times \underline{\hat{u}} = \frac{1}{\sqrt{2}}(-\underline{\hat{x}} + \underline{\hat{y}})$$

Example (cont.)

$$\begin{aligned}
 \underline{J}_s^{pTM} &= \left(\underline{J}_s^p \cdot \underline{\hat{u}} \right) \underline{\hat{u}} \\
 &= \left(\underline{\hat{x}} \cdot \underline{\hat{u}} \right) e^{-jk_0(x+y)} \underline{\hat{u}} \\
 &= \cos \phi_{pw} e^{-jk_0(x+y)} \underline{\hat{u}} \\
 &= \frac{1}{\sqrt{2}} e^{-jk_0(x+y)} \underline{\hat{u}} \\
 &= \frac{1}{2} \left(\underline{\hat{x}} + \underline{\hat{y}} \right) e^{-jk_0(x+y)}
 \end{aligned}$$

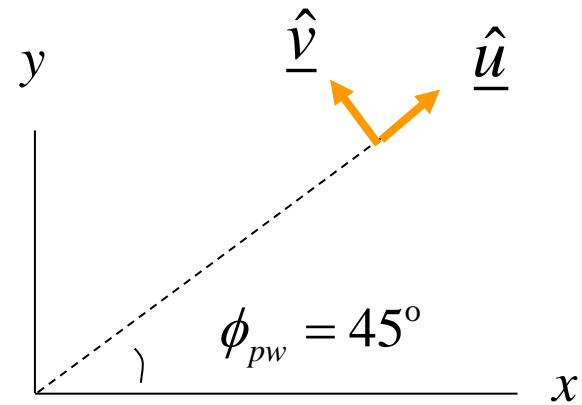

$$\begin{aligned}
 \underline{J}_s^{pTE} &= \left(\underline{J}_s^p \cdot \underline{\hat{v}} \right) \underline{\hat{v}} \\
 &= \left(\underline{\hat{x}} \cdot \underline{\hat{v}} \right) e^{-jk_0(x+y)} \underline{\hat{v}} \\
 &= -\sin \phi_{pw} e^{-jk_0(x+y)} \underline{\hat{v}} \\
 &= -\frac{1}{\sqrt{2}} e^{-jk_0(x+y)} \underline{\hat{v}} \\
 &= -\frac{1}{2} \left(-\underline{\hat{x}} + \underline{\hat{y}} \right) e^{-jk_0(x+y)}
 \end{aligned}$$

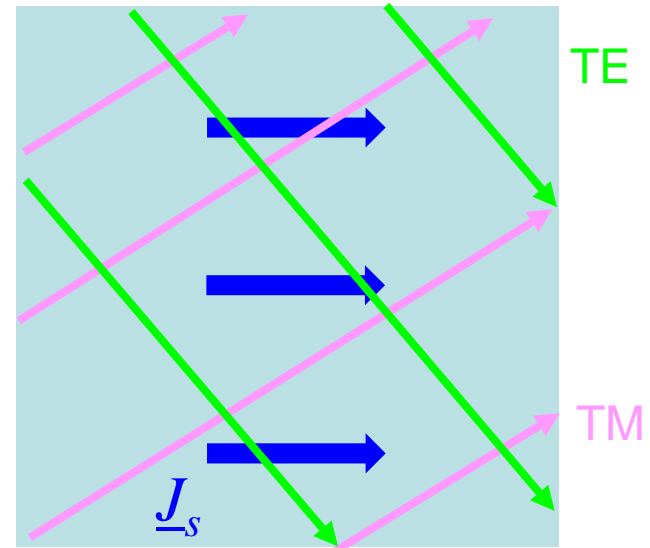

$$\underline{J}_s^p(x, y) = \underline{\hat{x}} e^{-jk_0(x+y)}$$

Example (cont.)

For the sources we have:

$$\begin{aligned} I_s^{TM} &= -\underline{J}_{s0}^p \cdot \underline{\hat{u}} \\ &= -\underline{\hat{x}} \cdot \underline{\hat{u}} \\ &= -\cos \phi_{pw} \\ &= -\frac{1}{\sqrt{2}} \end{aligned}$$

Recall:

$$\underline{J}_s^p(x, y) = \underline{\hat{x}} e^{-jk_0(x+y)}$$

$$\underline{J}_{s0}^p(x, y) = \underline{\hat{x}}$$

$$\begin{aligned} I_s^{TE} &= \underline{J}_{s0}^p \cdot \underline{\hat{v}} \\ &= \underline{\hat{x}} \cdot \underline{\hat{v}} \\ &= -\sin \phi_{pw} \\ &= -\frac{1}{\sqrt{2}} \end{aligned}$$

Example (cont.)

$$I_s^{TM} = -\frac{1}{\sqrt{2}}$$

$$I_s^{TE} = -\frac{1}{\sqrt{2}}$$

T denotes TM or TE

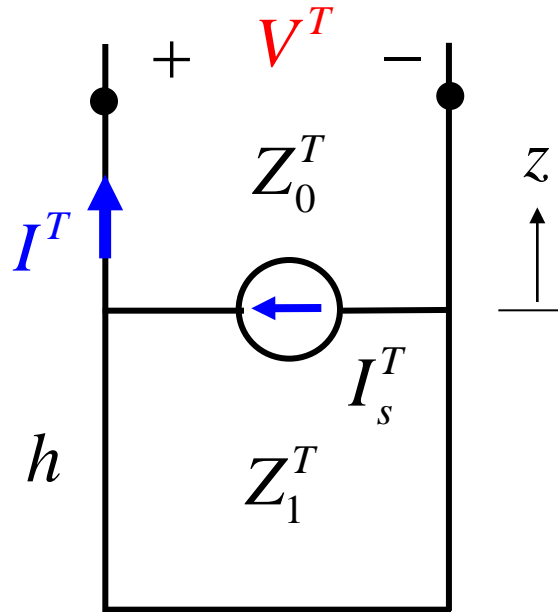

(TM_z or TE_z)

$$k_{z0} = (k_0^2 - k_0^2 - k_0^2)^{1/2} = -jk_0$$

$$k_{z1} = (k_1^2 - k_0^2 - k_0^2)^{1/2} = (k_1^2 - 2k_0^2)^{1/2}$$

From TL theory,

$$Z_{in} = Z_0 \parallel jZ_1 \tan(k_{z1}h)$$

$$Z_{in} = \frac{jZ_0Z_1 \tan(k_{z1}h)}{Z_0 + jZ_1 \tan(k_{z1}h)}$$

$$Z_0^{TM} = \frac{k_{z0}}{\omega\epsilon_0}$$

$$Z_1^{TM} = \frac{k_{z1}}{\omega\epsilon_1}$$

$$Z_0^{TE} = \frac{\omega\mu_0}{k_{z0}}$$

$$Z_1^{TE} = \frac{\omega\mu_1}{k_{z1}}$$

Example (cont.)

$$V^T(0) = Z_{in}^T I_s^T$$

$z \geq 0$

$$\begin{aligned} V^T(z) &= V^T(0) e^{-jk_z z} \\ &= Z_{in}^T I_s^T e^{-jk_z z} \end{aligned}$$

Hence

$$\begin{aligned} V^{TM}(z) &= Z_{in}^{TM} I_s^{TM} e^{-jk_z z} \\ &= Z_{in}^{TM} \left(-\frac{1}{\sqrt{2}} \right) e^{-jk_z z} \end{aligned}$$

Therefore,
$$E_u^p(0, 0, z) = Z_{in}^{TM} \left(-\frac{1}{\sqrt{2}} \right) e^{-jk_z z}$$

(TM_z or TE_z)

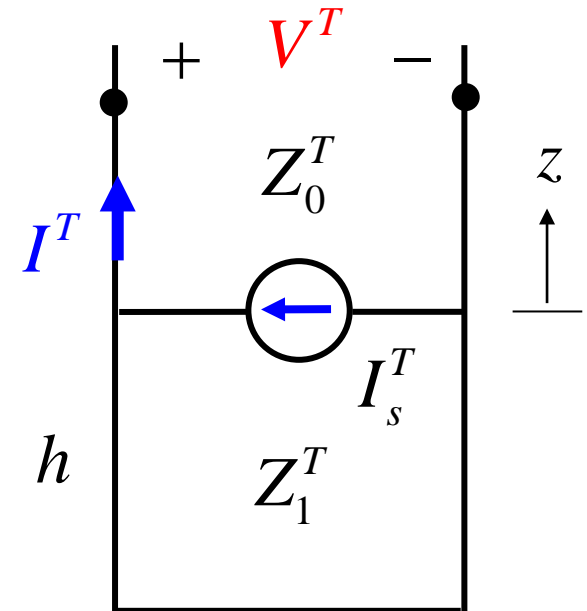

T denotes TM or TE

Example (cont.)

Similarly,

$$\begin{aligned} V^{TE}(z) &= Z_{in}^{TE} I_s^{TE} e^{-jk_z z} \\ &= Z_{in}^{TE} \left(-\frac{1}{\sqrt{2}} \right) e^{-jk_z z} \end{aligned}$$

Therefore,

$$-E_v^p(0,0,z) = Z_{in}^{TE} \left(-\frac{1}{\sqrt{2}} \right) e^{-jk_z z}$$

Example (cont.)

We then have

$$\underline{E}_t(x, y, z) = \underline{\hat{u}} \left[\underline{Z}_{in}^{TM} \left(-\frac{1}{\sqrt{2}} \right) e^{-jk_{z0}z} e^{-jk_0(x+y)} \right] + \underline{\hat{v}} \left[-\underline{Z}_{in}^{TE} \left(-\frac{1}{\sqrt{2}} \right) e^{-jk_{z0}z} e^{-jk_0(x+y)} \right]$$

where

$$\underline{Z}_{in}^T = \frac{j\underline{Z}_0^T \underline{Z}_1^T \tan(k_{z1}h)}{\underline{Z}_0^T + j\underline{Z}_1^T \tan(k_{z1}h)}$$

$$\underline{\hat{u}} = \frac{1}{\sqrt{2}} (\underline{\hat{x}} + \underline{\hat{y}})$$

$$\underline{\hat{v}} = \underline{\hat{z}} \times \underline{\hat{u}} = \frac{1}{\sqrt{2}} (-\underline{\hat{x}} + \underline{\hat{y}})$$

with

$$k_{z0} = (k_0^2 - k_0^2 - k_0^2)^{1/2} = -jk_0$$

$$k_{z1} = (k_1^2 - k_0^2 - k_0^2)^{1/2} = (k_1^2 - 2k_0^2)^{1/2}$$

$$\underline{Z}_0^{TM} = \frac{k_{z0}}{\omega \epsilon_0} \quad \underline{Z}_1^{TM} = \frac{k_{z1}}{\omega \epsilon_1}$$

$$\underline{Z}_0^{TE} = \frac{\omega \mu_0}{k_{z0}} \quad \underline{Z}_1^{TE} = \frac{\omega \mu_1}{k_{z1}}$$

Michalski Notation

The infinite current sheet produces a field

$$\underline{E}_t^P(x, y) = \underline{E}_{t0}^P e^{-j(k_x x + k_y y)}$$

where

$$\begin{aligned}\underline{E}_{t0}^P &= \underline{\hat{u}} E_{u0} + \underline{\hat{v}} E_{v0} \\ &= \underline{\hat{u}} V^{TM}(z) + \underline{\hat{v}}(-V^{TE}(z)) \\ &= \underline{\hat{u}} V_i^{TM}(z) \left[-\underline{J}_{s0}^P \cdot \underline{\hat{u}} \right] + \underline{\hat{v}}(-V_i^{TE}(z)) \left[+\underline{J}_{s0}^P \cdot \underline{\hat{v}} \right]\end{aligned}$$

The “*i*” subscript on the voltage functions denotes the voltage due to a *one-Amp parallel current source*.

Finite Source

Recall that

$$\underline{J}_{s0}^P = \underline{A}_{mn} = \frac{1}{(2\pi)^2} \underline{\tilde{J}}_s(k_{xm}, k_{yn}) \Delta k_x \Delta k_y$$

Hence

$$\underline{E}_{t0}^P = \underline{\hat{u}} V_i^{TM}(z) \left[\frac{1}{(2\pi)^2} \left[-\underline{\tilde{J}}_s(k_{xm}, k_{yn}) \cdot \underline{\hat{u}} \right] \Delta k_x \Delta k_y \right] \\ - \underline{\hat{v}} V_i^{TE}(z) \left[\frac{1}{(2\pi)^2} \left[\underline{\tilde{J}}_s(k_{xm}, k_{yn}) \cdot \underline{\hat{v}} \right] \Delta k_x \Delta k_y \right]$$

where

$$\underline{\hat{u}} = \underline{\hat{u}}(k_{xm}, k_{yn}) \quad V_i^{TM}(z) = V_i^{TM}(k_t^{mn}, z)$$

$$\underline{\hat{v}} = \underline{\hat{v}}(k_{xm}, k_{yn}) \quad V_i^{TE}(z) = V_i^{TE}(k_t^{mn}, z)$$

$$k_t^{mn} = (k_{xm}^2 + k_{yn}^2)^{1/2}$$

Finite Source (cont.)

Adding the contributions from all the phased current sheets, we have

$$\underline{E}_t(x, y) = \frac{1}{(2\pi)^2} \sum_{m=-\infty}^{\infty} \sum_{n=-\infty}^{\infty} \left[\begin{array}{l} \underline{\hat{u}} V_i^{TM}(z) \left(-\underline{\tilde{J}}_s(k_{xm}, k_{yn}) \cdot \underline{\hat{u}} \right) \\ -\underline{\hat{v}} V_i^{TE}(z) \left(\underline{\tilde{J}}_s(k_{xm}, k_{yn}) \cdot \underline{\hat{v}} \right) \end{array} \right] e^{-j(k_{xm}x + k_{yn}y)} \Delta k_x \Delta k_y$$

Taking the limit as

$$\Delta k_x \rightarrow dk_x$$

$$\Delta k_y \rightarrow dk_y$$

$$\underline{E}_t(x, y) = \frac{1}{(2\pi)^2} \int_{-\infty}^{\infty} \int_{-\infty}^{\infty} \left[\begin{array}{l} \underline{\hat{u}} V_i^{TM}(z) \left(-\underline{\tilde{J}}_s(k_x, k_y) \cdot \underline{\hat{u}} \right) \\ -\underline{\hat{v}} V_i^{TE}(z) \left(\underline{\tilde{J}}_s(k_x, k_y) \cdot \underline{\hat{v}} \right) \end{array} \right] e^{-j(k_x x + k_y y)} dk_x dk_y$$

TEN for Transform of Fields

From this we can identify

$$\underline{\tilde{E}}_t(k_x, k_y, z) = \underline{\hat{u}} V_i^{TM}(z) (-\underline{\tilde{J}}_s \cdot \underline{\hat{u}}) - \underline{\hat{v}} V_i^{TE}(z) (\underline{\tilde{J}}_s \cdot \underline{\hat{v}})$$

Taking the u and v components, we have

$$\begin{aligned}\underline{\hat{u}} \cdot \underline{\tilde{E}}_t &= V_i^{TM}(z) (-\underline{\tilde{J}}_s \cdot \underline{\hat{u}}) \\ -\underline{\hat{v}} \cdot \underline{\tilde{E}}_t &= V_i^{TE}(z) (+\underline{\tilde{J}}_s \cdot \underline{\hat{v}})\end{aligned}$$

From this we can make the following TEN identifications:

$$\begin{aligned}V^{TM}(z) &= \underline{\hat{u}} \cdot \underline{\tilde{E}}_t(k_x, k_y, z) & I_s^{TM}(z) &= -\underline{\hat{u}} \cdot \underline{\tilde{J}}_s(k_x, k_y) \\ V^{TE}(z) &= -\underline{\hat{v}} \cdot \underline{\tilde{E}}_t(k_x, k_y, z) & I_s^{TE}(z) &= \underline{\hat{v}} \cdot \underline{\tilde{J}}_s(k_x, k_y)\end{aligned}$$

TEN for Transform of Fields (cont.)

The TEN models are shown below.

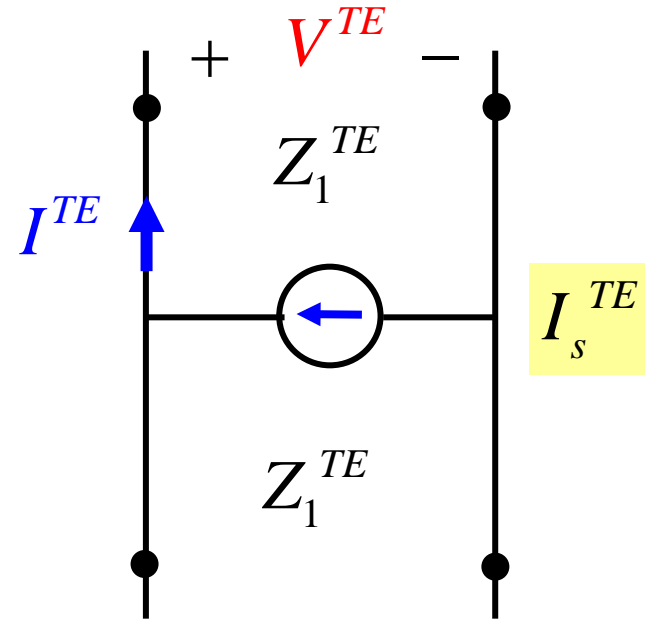
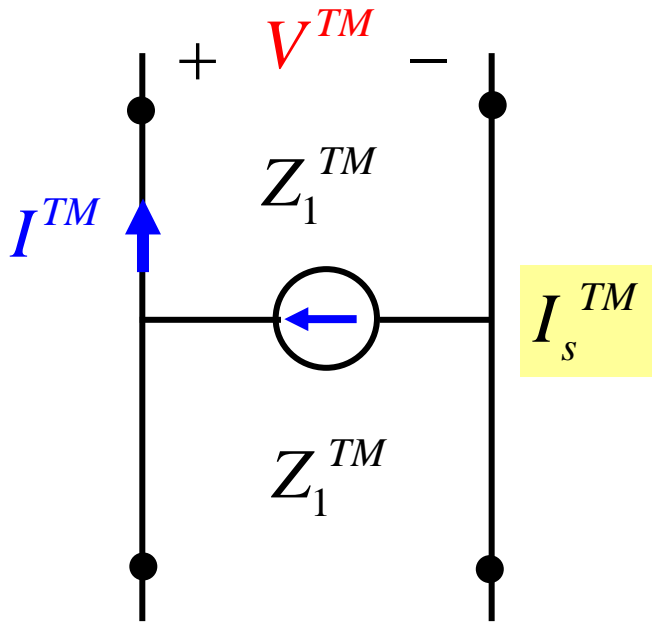

$$V^{TM}(z) = \hat{u} \cdot \tilde{\underline{E}}_t(k_x, k_y, z)$$

$$I_s^{TM}(z) = -\hat{u} \cdot \tilde{\underline{J}}_s(k_x, k_y)$$

$$V^{TE}(z) = -\hat{v} \cdot \tilde{\underline{E}}_t(k_x, k_y, z)$$

$$I_s^{TE}(z) = \hat{v} \cdot \tilde{\underline{J}}_s(k_x, k_y)$$

Summary

(for modeling the transform of the field)

$$V^{TM}(z) = \underline{\hat{u}} \cdot \underline{\tilde{E}}_t(k_x, k_y, z)$$

$$I^{TM}(z) = \underline{\hat{v}} \cdot \underline{\tilde{H}}_t(k_x, k_y, z)$$

$$I_s^{TM}(z) = -\underline{\hat{u}} \cdot \underline{\tilde{J}}_s(k_x, k_y)$$

$$V^{TE}(z) = -\underline{\hat{v}} \cdot \underline{\tilde{E}}_t(k_x, k_y, z)$$

$$I^{TE}(z) = \underline{\hat{u}} \cdot \underline{\tilde{H}}_t(k_x, k_y, z)$$

$$I_s^{TE}(z) = \underline{\hat{v}} \cdot \underline{\tilde{J}}_s(k_x, k_y)$$

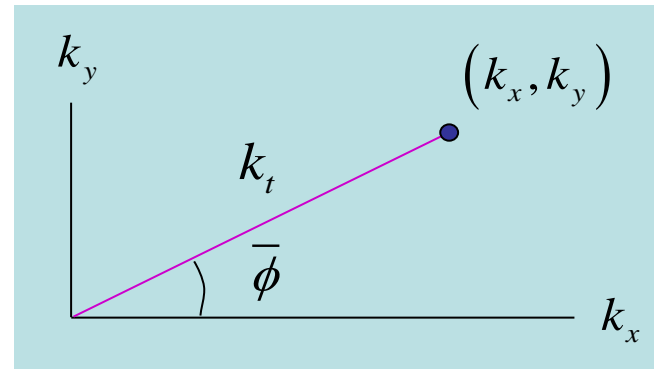
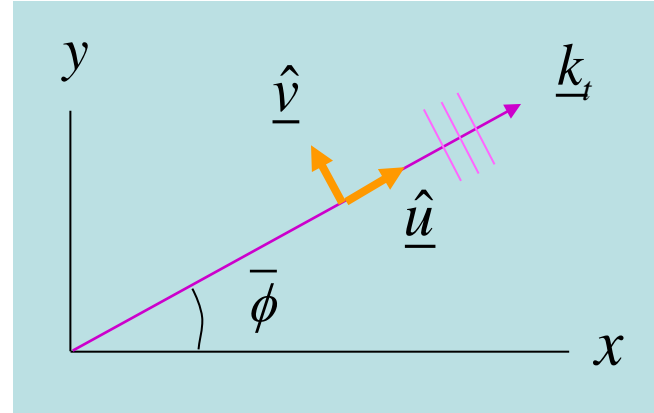

- ◇ The angle of propagation in the horizontal plane is denoted as $\bar{\phi}$
- ◇ This is also the angle in the spectral wavenumber plane.

Spectral-Domain Green's Function

- Assume an x -directed surface current J_{sx} .
- Assume that we wish to find E_x .

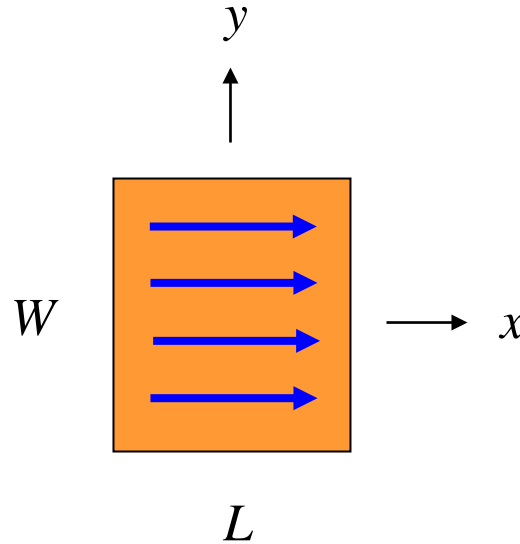

This is the most useful case for the rectangular microstrip antenna.

Spectral-Domain Green's Function

$$\tilde{\underline{E}}_x = \tilde{\underline{E}}_t \cdot \hat{\underline{x}}$$

This is a typical “spectral-domain calculation.”

$$= \left[\left(\tilde{\underline{E}}_t \cdot \hat{\underline{u}} \right) \hat{\underline{u}} + \left(\tilde{\underline{E}}_t \cdot \hat{\underline{v}} \right) \hat{\underline{v}} \right] \cdot \hat{\underline{x}}$$

$$= \left[\left(V^{TM}(z) \right) \hat{\underline{u}} + \left(-V^{TE}(z) \right) \hat{\underline{v}} \right] \cdot \hat{\underline{x}}$$

$$= V^{TM}(z) \begin{pmatrix} k_x \\ k_t \end{pmatrix} - V^{TE}(z) \begin{pmatrix} -k_y \\ k_t \end{pmatrix}$$

$$= \begin{pmatrix} k_x \\ k_t \end{pmatrix} V_i^{TM}(z) [I_s^{TM}] + \begin{pmatrix} k_y \\ k_t \end{pmatrix} (V_i^{TE}(z)) [I_s^{TE}]$$

$$= \begin{pmatrix} k_x \\ k_t \end{pmatrix} V_i^{TM}(z) [-\tilde{\underline{J}}_s \cdot \hat{\underline{u}}] + \begin{pmatrix} k_y \\ k_t \end{pmatrix} (V_i^{TE}(z)) [\tilde{\underline{J}}_s \cdot \hat{\underline{v}}]$$

$$= \begin{pmatrix} k_x \\ k_t \end{pmatrix} V_i^{TM}(z) [-\hat{\underline{x}} \cdot \hat{\underline{u}}] \tilde{\underline{J}}_{sx} + \begin{pmatrix} k_y \\ k_t \end{pmatrix} (V_i^{TE}(z)) [\hat{\underline{x}} \cdot \hat{\underline{v}}] \tilde{\underline{J}}_{sx}$$

$$= -\begin{pmatrix} k_x \\ k_t \end{pmatrix}^2 V_i^{TM}(z) \tilde{\underline{J}}_{sx} - \begin{pmatrix} k_y \\ k_t \end{pmatrix}^2 V_i^{TE}(z) \tilde{\underline{J}}_{sx}$$

$$= \left[-\begin{pmatrix} k_x \\ k_t \end{pmatrix}^2 V_i^{TM}(z) - \begin{pmatrix} k_y \\ k_t \end{pmatrix}^2 V_i^{TE}(z) \right] \tilde{\underline{J}}_{sx}$$

Recall:

$$\hat{\underline{u}} \cdot \hat{\underline{x}} = \cos \bar{\phi} = k_x / k_t$$

$$\hat{\underline{v}} \cdot \hat{\underline{x}} = -\sin \bar{\phi} = -k_y / k_t$$

Spectral-Domain Green's Function (cont.)

Define

$$\tilde{G}_{xx}(k_x, k_y, z) \equiv -\left(\frac{k_x}{k_t}\right)^2 V_i^{TM}(z) - \left(\frac{k_y}{k_t}\right)^2 V_i^{TE}(z)$$

Then

$$\tilde{E}_x = \tilde{G}_{xx} \tilde{J}_{sx}$$

This is the “xx component of the spectral-domain Green’s function.”

Taking the inverse transform, we have:

$$E_x = \frac{1}{(2\pi)^2} \int_{-\infty}^{+\infty} \int_{-\infty}^{+\infty} \tilde{G}_{xx}(k_x, k_y, z) \tilde{J}_{sx}(k_x, k_y) e^{-j(k_x x + k_y y)} dk_x dk_y$$

Spectral-Domain Green's Function (cont.)

The spectral-domain Green's function is the Fourier transform of the space-domain Green's function.

To see this:

$$\begin{aligned} E_x &= \int_{-\infty}^{\infty} \int_{-\infty}^{\infty} G_{xx}(x-x', y-y'; z, z') J_{sx}(x', y') dx' dy' \\ &= G_{xx} * J_{sx} \quad (\text{2D convolution}) \end{aligned}$$

The space-domain Green's function $G_{xx}(x, y; z, z')$ is the field $E_x(x, y, z)$ due to a unit-amplitude dipole located at $(0, 0, z')$.

From the convolution property of Fourier transforms: $\tilde{E}_x = F \{ G_{xx} \} \tilde{J}_{sx}$

Hence $\tilde{G}_{xx} = F \{ G_{xx} \}$

Spectral-Domain Green's Function (cont.)

More generally,

$$\begin{bmatrix} \tilde{E}_x \\ \tilde{E}_y \end{bmatrix} = \begin{bmatrix} \tilde{G}_{xx} & \tilde{G}_{xy} \\ \tilde{G}_{yx} & \tilde{G}_{yy} \end{bmatrix} \begin{bmatrix} \tilde{J}_{sx} \\ \tilde{J}_{sy} \end{bmatrix}$$

The other three components can be found in a similar manner:

$$\tilde{G}_{xy}, \tilde{G}_{yx}, \tilde{G}_{yy}$$

Note: $\tilde{G}_{xy} = \tilde{G}_{yx}$ from reciprocity.

Summary

(for the E_x field from an x -directed electric current)

$$\tilde{E}_x = \tilde{G}_{xx} \tilde{J}_{sx}$$

where

$$\tilde{G}_{xx}(k_x, k_y, z) \equiv -\left(\frac{k_x}{k_t}\right)^2 V_i^{TM}(z) - \left(\frac{k_y}{k_t}\right)^2 V_i^{TE}(z)$$

Taking the inverse transform, we have:

$$E_x = \frac{1}{(2\pi)^2} \int_{-\infty}^{+\infty} \int_{-\infty}^{+\infty} \tilde{G}_{xx}(k_x, k_y, z) \tilde{J}_{sx}(k_x, k_y) e^{-j(k_x x + k_y y)} dk_x dk_y$$

Summary (cont.)

The TEN models are shown below.

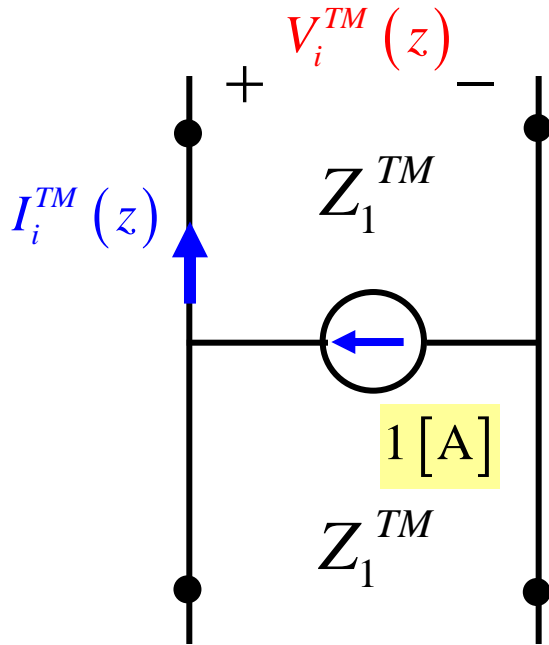

$$Z_0^{TM} = \frac{k_{z0}}{\omega \epsilon_0}$$

$$Z_1^{TM} = \frac{k_{z1}}{\omega \epsilon_1}$$

etc.

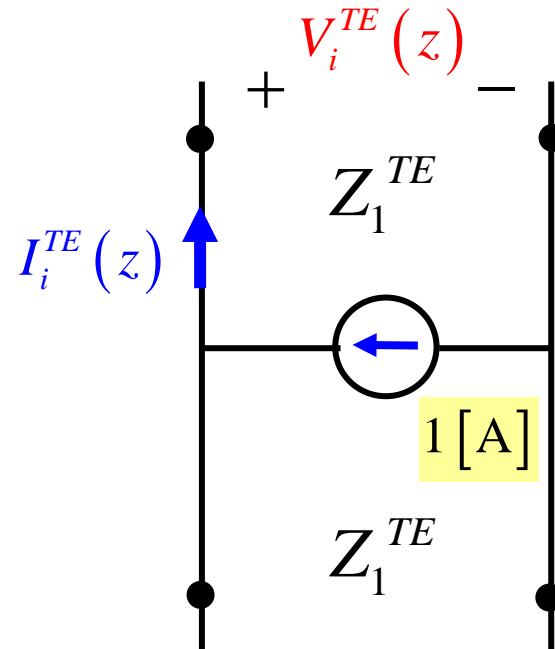

$$Z_0^{TE} = \frac{\omega \mu_0}{k_{z0}}$$

$$Z_1^{TE} = \frac{\omega \mu_1}{k_{z1}}$$

etc.